



SSCZXXXBS6 Series

Zener Voltage Regulator

● Description

The SSCZXXXBS6 is packaged in a SOT-23 surface mount package that has a power dissipation of 300mW. They are designed to provide voltage regulation protection and are especially attractive in situations where space is at a premium. It is applicable to mobile phones, hand-held portable devices, high-density PC boards.

● PIN configuration

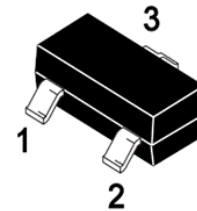

SOT-23

● Feature

- ✧ Low profile package
- ✧ Ideal for automated placement
- ✧ Low Zener Impedance
- ✧ Steady state power rating of 300mW
- ✧ RoHS compliant transient



Circuit Diagram

● Applications

- ✧ Hand held portables
- ✧ Cellular phones
- ✧ High density PC boards

● Mechanical data

- ✧ Package: SOT-23
- ✧ Lead finish:100% matte Sn (Tin)
- ✧ Mounting position: Any
- ✧ Qualified max reflow temperature:260°C
- ✧ Device meets MSL 3 requirements
- ✧ Pure tin plating: 7 ~ 17 um
- ✧ Pin flatness: ≤3mil

● Absolute maximum rating @T_A=25°C

Parameter	Symbol	Value	Unit
Total Device Dissipation FR-5 Board	P _D	300	mW
Forward Voltage @ I _F = 10mA	V _F	0.9	V
Storage Temperature	T _{STG}	-55/+150	°C
Operating Temperature	T _J	-55/+150	°C



● **Electrical Characteristics (T_A=25°C unless otherwise noted)**

Device	Marking	Zener Voltage Range				Maximum Zener Impedance			Maximum Reverse Current		Typical Temperature coefficient @ I _{ZTC} =mV/°C		Test Current I _{ZTC}
		V _Z @ I _{ZT}			I _{ZT}	Z _{ZT} @I _{ZT}	Z _{ZK} @I _{ZK}	I _{ZK}	I _R	V _R	Min	Max	
		Nom(V)	Min(V)	Max(V)	mA	Ω	mA	μA	V	mA			
SSCZ2V4BS6	2Z11	2.4	2.35	2.45	5	100	600	1.0	50	1.0	-3.5	0	5
SSCZ2V7BS6	2Z12	2.7	2.65	2.75	5	100	600	1.0	20	1.0	-3.5	0	5
SSCZ3V0BS6	2Z13	3.0	2.94	3.06	5	95	600	1.0	10	1.0	-3.5	0	5
SSCZ3V3BS6	2Z14	3.3	3.23	3.37	5	95	600	1.0	5	1.0	-3.5	0	5
SSCZ3V6BS6	2Z15	3.6	3.53	3.67	5	90	600	1.0	5	1.0	-3.5	0	5
SSCZ3V9BS6	2Z16	3.9	3.82	3.98	5	90	600	1.0	3	1.0	-3.5	0	5
SSCZ4V3BS6	2Z17	4.3	4.21	4.39	5	90	600	1.0	3	1.0	-3.5	0	5
SSCZ4V7BS6	2Z1	4.7	4.61	4.79	5	80	500	1.0	3	2.0	-3.5	0.2	5
SSCZ5V1BS6	2Z2	5.1	5.00	5.20	5	60	480	1.0	2	2.0	-2.7	1.2	5
SSCZ5V6BS6	2Z3	5.6	5.49	5.71	5	40	400	1.0	1	2.0	-2.0	2.5	5
SSCZ6V2BS6	2Z4	6.2	6.08	6.32	5	10	150	1.0	3	4.0	0.4	3.7	5
SSCZ6V8BS6	2Z5	6.8	6.66	6.94	5	15	80	1.0	2	4.0	1.2	4.5	5
SSCZ7V5BS6	2Z6	7.5	7.35	7.65	5	15	80	1.0	1	5.0	2.5	5.3	5
SSCZ8V2BS6	2Z7	8.2	8.04	8.36	5	15	80	1.0	0.7	5.0	3.2	6.2	5
SSCZ9V1BS6	2Z8	9.1	8.92	9.28	5	15	100	1.0	0.5	6.0	3.8	7.0	5
SSCZ10VBS6	2Z9	10	9.80	10.20	5	20	150	1.0	0.2	7.0	4.5	8.0	5
SSCZ11VBS6	2Y1	11	10.78	11.22	5	20	150	1.0	0.1	8.0	5.4	9.0	5
SSCZ12VBS6	2Y2	12	11.76	12.24	5	25	150	1.0	0.1	8.0	6.0	10.0	5
SSCZ13VBS6	2Y3	13	12.74	13.26	5	30	170	1.0	0.1	8.0	7.0	11.0	5
SSCZ15VBS6	2Y4	15	14.70	15.30	5	30	200	1.0	0.1	10.5	9.2	13.0	5
SSCZ16VBS6	2Y5	16	15.68	16.32	5	40	200	1.0	0.1	11.2	10.4	14.0	5
SSCZ18VBS6	2Y6	18	17.64	18.36	5	45	225	1.0	0.1	12.6	12.4	16.0	5
SSCZ20VBS6	2Y7	20	19.60	20.40	5	55	225	1.0	0.1	14.0	14.4	18.0	5
SSCZ22VBS6	2Y8	22	21.56	22.44	5	55	250	1.0	0.1	15.4	16.4	20.0	5
SSCZ24VBS6	2Y9	24	23.52	24.48	5	70	250	1.0	0.1	16.8	18.4	22.0	5
SSCZ27VBS6	2Y10	27	26.46	27.54	2	80	300	0.5	0.1	18.9	21.4	25.3	2
SSCZ30VBS6	2Y11	30	29.40	30.60	2	80	300	0.5	0.1	21.0	24.4	29.4	2
SSCZ33VBS6	2Y12	33	32.34	33.66	2	80	325	0.5	0.1	23.1	27.4	33.4	2
SSCZ36VBS6	2Y13	36	35.28	36.72	2	90	350	0.5	0.1	25.2	30.4	37.4	2
SSCZ39VBS6	2Y14	39	38.22	39.78	2	130	350	0.5	0.1	27.3	33.4	41.2	2



● Typical Performance Characteristics ($T_A=25^\circ\text{C}$ unless otherwise noted)

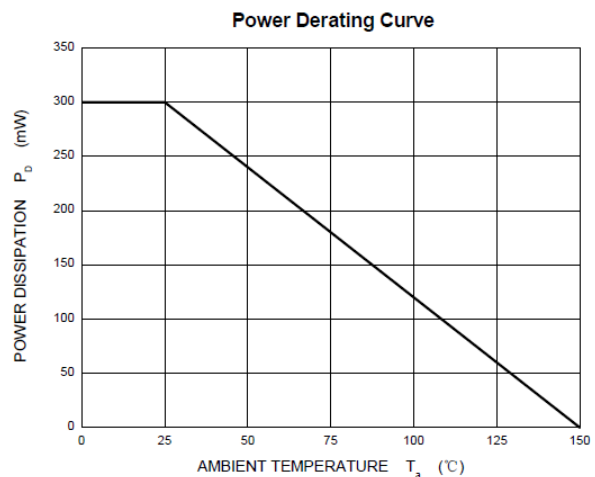
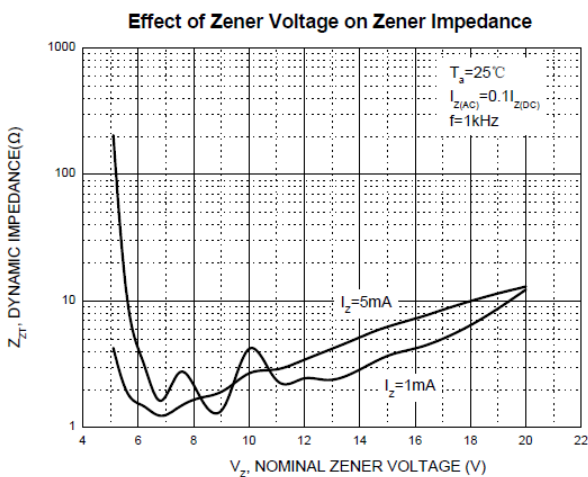
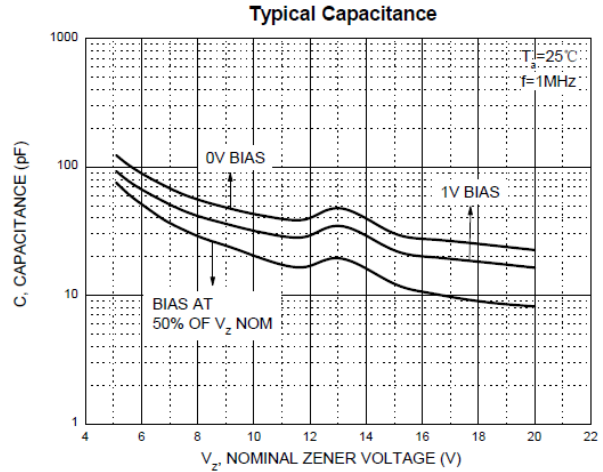
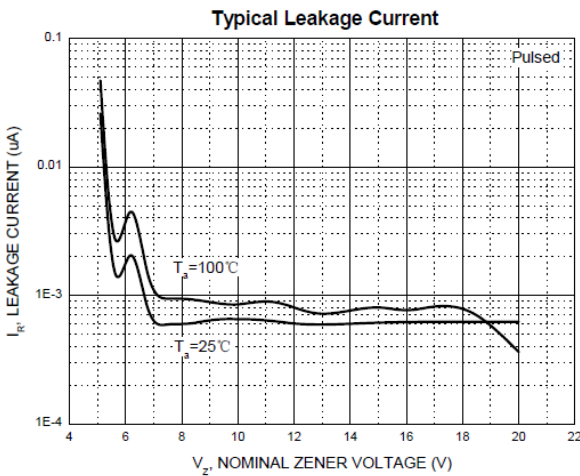
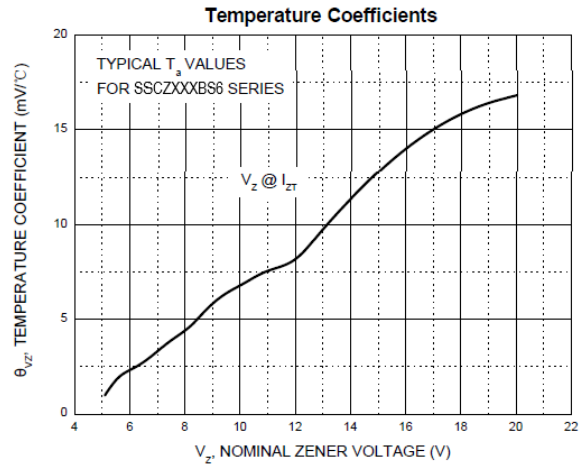
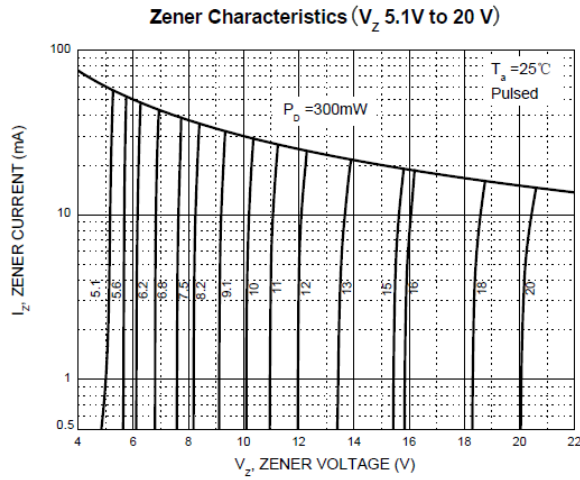



● Package Information

Ordering Information

Device	Package	Qty per Reel	Reel Size
SSCZXXXBS6	SOT-23	3000	7 Inch

Mechanical Data

Case: SOT-23

Case Material: Molded Plastic. UL Flammability

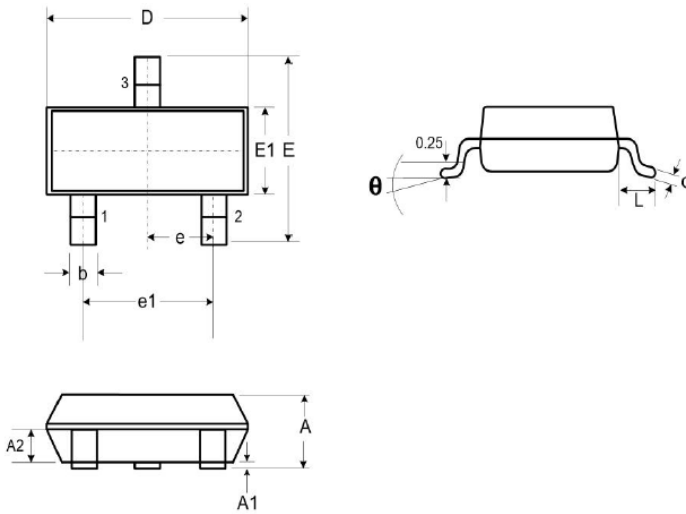

DIM	Millimeters		
	Min.	Typ.	Max.
A	0.89	-	1.12
A1	0.01	-	0.10
A2	0.88	0.95	1.02
b	0.30	-	0.51
c	0.08	-	0.18
D	2.80	2.90	3.04
E	2.10	2.37	2.64
E1	1.20	1.30	1.40
e	1.90		
e1	0.95		
L	0.40	0.50	0.60
L1	0.55		
N	3		
theta	0°	-	8°

Recommended Pad outline (Unit: mm)

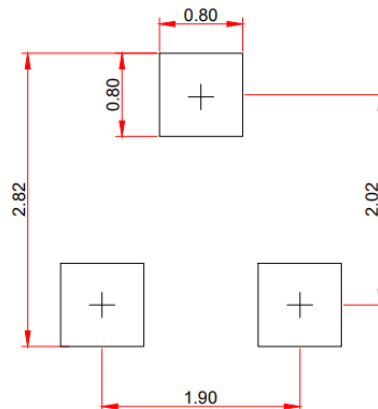



DISCLAIMER

AFSEMI RESERVES THE RIGHT TO MAKE CHANGES WITHOUT FURTHER NOTICE TO ANY PRODUCTS HEREIN TO IMPROVE RELIABILITY, FUNCTION OR DESIGN. AFSEMI DOES NOT ASSUME ANY LIABILITY ARISING OUT OF THE APPLICATION OR USE OF ANY PRODUCT OR CIRCUIT DESCRIBED HEREIN; NEITHER DOES IT CONVEY ANY LICIENCE UNDER ITS PATENT RIGHTS, NOR THE RIGHTS OF OTHERS.

THE GRAPHS PROVIDED IN THIS DOCUMENT ARE STATISTICAL SUMMARIES BASED ON A LIMITED NUMBER OF SAMPLES AND ARE PROVIDED FOR INFORMATIONAL PURPOSE ONLY. THE PERFORMANCE CHARACTERISTICS LISTED IN THEM ARE NOT TESTED OR GUARANTEED. IN SOME GRAPHS, THE DATA PRESENTED MAY BE OUTSIDE THE SPECIFIED OPERATING RANGE (E.G. OUTSIDE SPECIFIED POWER SUPPLY RANGE) AND THEREFORE OUTSIDE THE WARRANTED RANGE.